

Fig. 01

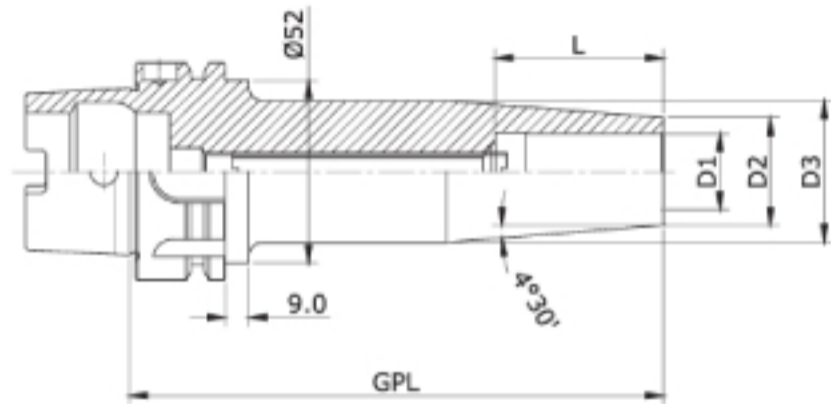

Fig. 02